



Installation & Operation Manual

AudioWizard[®] 2.0

mr.steam[®] | Feel Good Inc.

IMPORTANT SAFETY INSTRUCTIONS

- Read these instructions.
- Keep these instructions.
- Heed all warnings.
- Follow all instructions.
- Do not use this apparatus near water.
- Clean only with a dry cloth
- Install in accordance with the manufacturer's instructions.
- Do not install near any heat sources such as radiators, heat registers, stoves or other apparatus (including amplifiers) that produce heat.
- Do not defeat the safety purpose of the polarized or grounding type plug. A polarized plug has two blades with one wider than the other. A grounding type plug has two blades and a third grounding prong. The wide blade or the third prong are provided for your safety. If the provided plug does not fit into your outlet, consult an electrician for replacement of the obsolete outlet.
- Protect the power cord from being walked on or pinched, particularly at plugs, convenience receptacles and the point where they exit from the apparatus.
- Only use attachments/accessories specified by the manufacturer.
- Unplug this apparatus during lightning storms or when unused for long periods of time.
- Refer all servicing to qualified service personnel. Servicing is required when the apparatus has been damaged in any way, such as power-supply cord or plug is damaged, liquid has been spilled or objects have fallen into the apparatus, the apparatus has been exposed to rain or moisture, does not operate normally or has been dropped.

As you follow these instructions, you will notice warning and caution symbols. This blocked information is important for the safe and efficient installation and operation of this AudioWizard control. These are types of potential hazards that may occur during installation and operation:

! WARNING states a hazard may cause serious injury or death if precautions are not followed.

! CAUTION signals a situation where minor injury or product damage may occur if you do not follow instructions.

IMPORTANT NOTE: This highlights information that is especially relevant to a problem-free installation.

! CAUTION These servicing instructions are for use by qualified service personnel only. To reduce the risk of electric shock, do not perform any servicing other than that contained in the operating instructions.

Table of Contents:

INSTALLATION	_____
Safety Instructions2
Box Contents2
Control Options3
Wiring & Speaker Connections3
Dimensional Information3
Locating the AudioWizard®4
AW Control Cable Installation4
AudioWizard Control Installation4
Connecting the Control to AudioWizard	..5
OPERATION	_____
Safety Instructions6
Pairing with a Bluetooth® Device6
iSteam Interface7
AW Control Interface7
Specifications8
Warranty8

BOX CONTENTS:

- A:** AudioWiz-iS
(use with *iSteam®* control)
- AudioWizard
- OR
- B:** AudioWiz-BK
(use with *eTempo* & *iTempo* controls)
- AudioWizard
 - AW Control

AudioWizard® 2.0

The AudioWizard sound system is the perfect way to bring music into your steam room or shower. The AudioWizard is easy to install and is compatible with many audio sources such as portable music players and smart phones equipped with Bluetooth®.

The AudioWizard can be controlled with the iSteam steam bath control or with the AW stand-alone control.

The AudioWizard is equipped with a Bluetooth® transceiver and an amplifier to host your speakers.

Just pair your Bluetooth® device and start playing your favorite music. Digital files or internet radio from your audio device will be sent wirelessly to the AudioWizard device located behind the wall, above the ceiling, or within a vanity closet.

! WARNING Prolonged use of the steam system can raise excessively the internal human body temperature and impair the body's ability to regulate its internal temperature (hyperthermia). Limit your use of steam to 10 - 15 minutes until you are certain of your body's reaction. See the Mr. Steam Residential Steam Bath Generator System Installation Operation and Maintenance manual (PUR 100472) for complete details on steam room use. The manual can be downloaded at www.mrsteam.com/support/downloads.html

Control Options for the AudioWizard®

A. Operating the AudioWizard with the iSteam control.

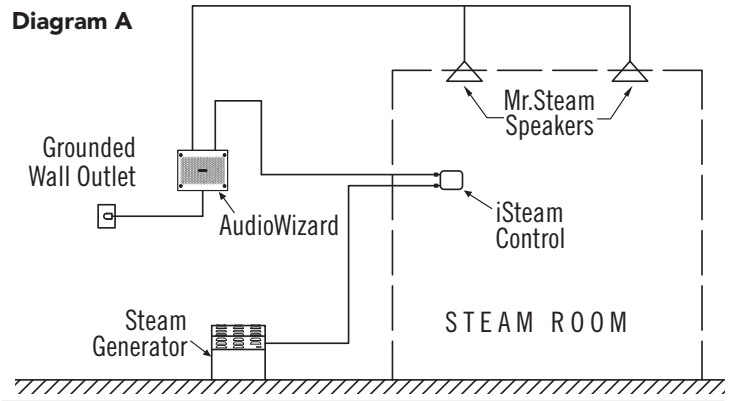

B. Operating the AudioWizard with the AudioWizard stand-alone control.

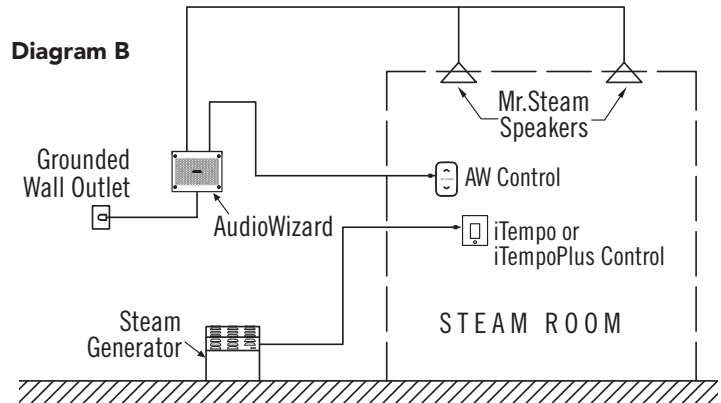

Wiring Connections and Dimensional Information

IMPORTANT NOTE: The terminals are removable. For ease of installation, remove terminals before connecting wires to them. 16 AWG type CL2 wire (minimum) should be used to connect speakers. Wire gauge and type may vary based on length of run and local codes, consult a licensed electrician for specific installation requirements.

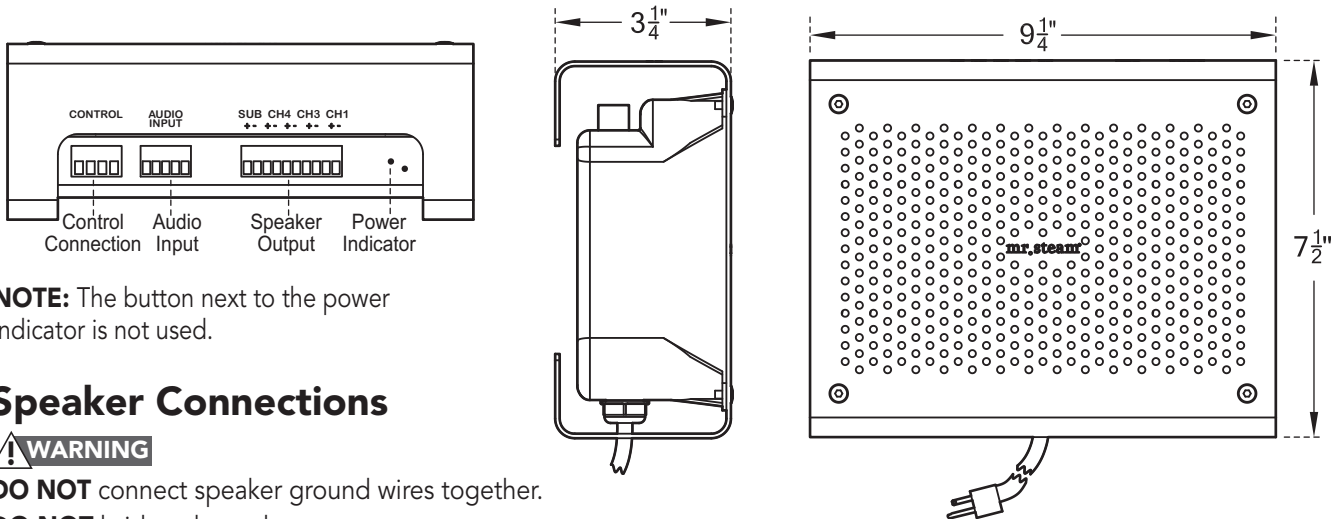

NOTE: The button next to the power indicator is not used.

Speaker Connections

! WARNING
DO NOT connect speaker ground wires together.
DO NOT bridge channels

Locating the AudioWizard®

The AudioWizard control cable is 30ft and the power cord is 6ft, ensure the control and AudioWizard are located accordingly.

Locate in a dry location where the wireless signal will not be interrupted. Test Bluetooth® signal before mounting AudioWizard.

⚠ WARNING ELECTRIC SHOCK HAZARD!

To reduce the risk of fire or electric shock, do not expose this apparatus to rain or moisture. DO NOT install AudioWizard in the steam room or any location where it may become wet.

Mounting Instructions

The AudioWizard can be mounted to a wall using the keyhole slots provided, or placed on any horizontal surface.

⚠ WARNING AudioWizard shall be connected to a main socket with a protective earthing connection. The socket shall remain readily accessible.

AW Control Cable Installation

⚠ CAUTION Do not force or twist cable connectors together. Forcing or twisting cable connectors may damage the connectors.

⚠ CAUTION Do not route the AudioWizard control cable inside conduit together with power wires, close to hot water or steam piping. Do not strain, staple, pinch or otherwise damage the AudioWizard control cable. Doing so may result in an inoperative installation.

Route the AudioWizard control cable from the AudioWizard to the desired control location. If using an iSteam control see the iSteam Control IOM (PUR 100477) for complete details on locating and installing the iSteam control.

AW Control Installation

(The AW control is not required when used with an iSteam Control.)

To install the AW control, select the most convenient location for the control. A 1" diameter hole is needed to mount the control. Clean the surface, peel the backing paper from the adhesive on the control, run a bead of silicone around the back of the control to ensure a water tight seal and insert the control into the hole (see illustration).

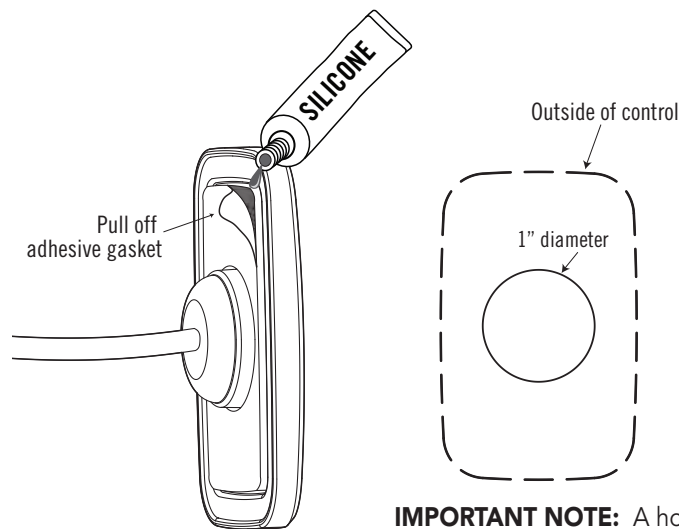

IMPORTANT NOTE: A hole larger than 1 inch diameter will not be sealed or covered by the AW Control.

All drawings are for illustrative purposes only.

Connecting the Control to AudioWizard®

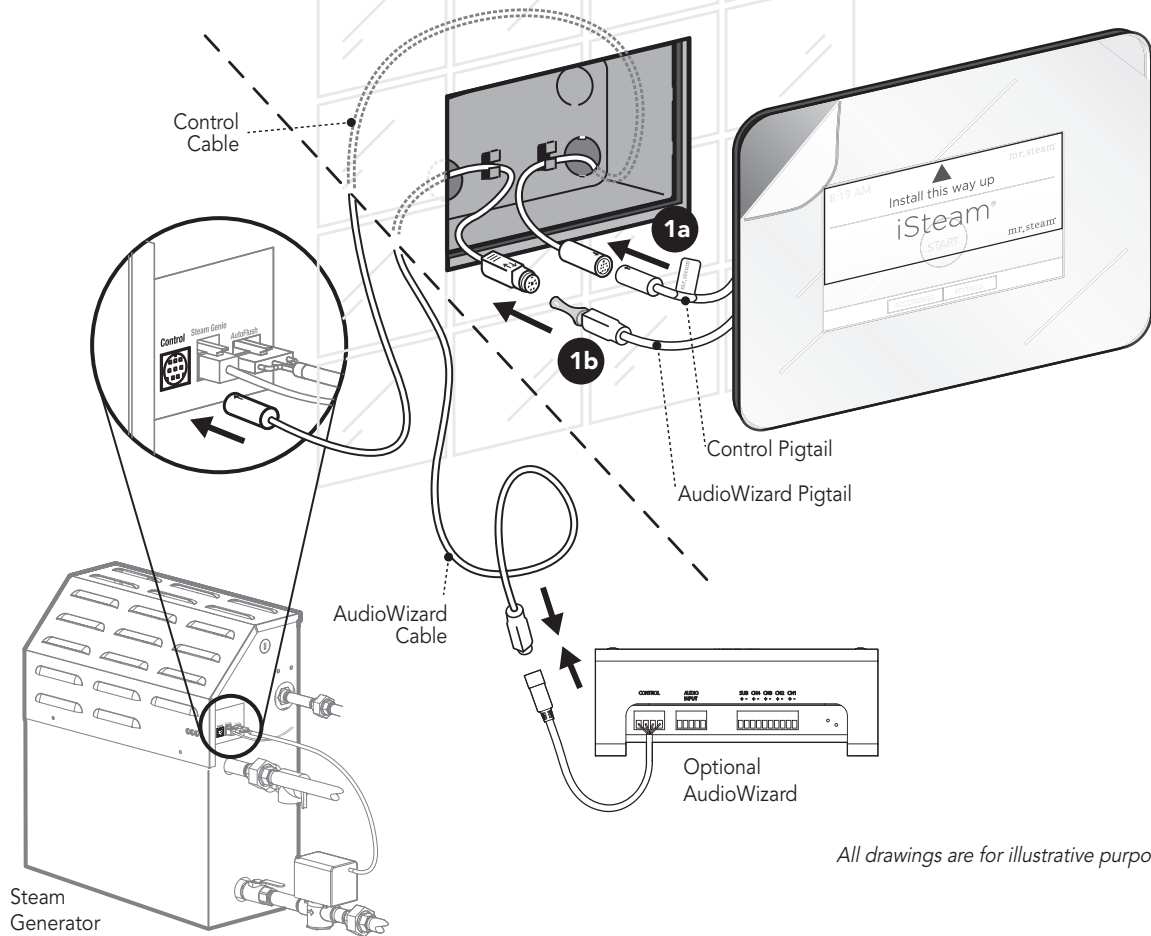

All drawings are for illustrative purposes only.

The AudioWizard must be connected to either the iSteam® control or the AW control as shown. AudioWizard is supplied with a 30 ft. cable that has 6-pin mini-din male connectors on each end.

CAUTION Do not force or twist connectors together. Forcing or twisting connectors may damage the connectors.

iSteam

iSteam's audio pigtail is the shorter of the two pigtails, it is covered with a bluecap. Remove the blue cap and plug in the cable.

AW Control

Plug the AudioWizard cable into the AW control pigtail.

CAUTION All Audio wiring shall be installed in accordance with National Electric Code and local electrical codes.

IMPORTANT SAFETY INSTRUCTIONS

- Read these instructions.
- Keep these instructions.
- Heed all warnings.
- Follow all instructions.
- Do not use this apparatus near water.
- Clean only with a dry cloth
- Install in accordance with the manufacturer's instructions.
- Do not install near any heat sources such as radiators, heat registers, stoves or other apparatus (including amplifiers) that produce heat.
- Do not defeat the safety purpose of the polarized or grounding type plug. A polarized plug has two blades with one wider than the other. A grounding type plug has two blades and a third grounding prong. The wide blade or the third prong are provided for your safety. If the provided plug does not fit into your outlet, consult an electrician for replacement of the obsolete outlet.
- Protect the power cord from being walked on or pinched, particularly at plugs, convenience receptacles and the point where they exit from the apparatus.
- Only use attachments/accessories specified by the manufacturer.
- Unplug this apparatus during lightning storms or when unused for long periods of time.
- Refer all servicing to qualified service personnel. Servicing is required when the apparatus has been damaged in any way, such as power-supply cord or plug is damaged, liquid has been spilled or objects have fallen into the apparatus, the apparatus has been exposed to rain or moisture, does not operate normally or has been dropped.

As you follow these instructions, you will notice warning and caution symbols. This blocked information is important for the safe and efficient installation and operation of this AudioWizard control. These are types of potential hazards that may occur during installation and operation:

!WARNING states a hazard may cause serious injury or death if precautions are not followed.

!CAUTION signals a situation where minor injury or product damage may occur if you do not follow instructions.

IMPORTANT NOTE:

This highlights information that is especially relevant to a problem-free installation.

!WARNING Prolonged use of the steam system can raise excessively the internal human body temperature and impair the body's ability to regulate its internal temperature (hyperthermia). Limit your use of steam to 10 -15 minutes until you are certain of your body's reaction. See the Mr. Steam Residential Steam Bath Generator System Installation Operation and Maintenance manual (PUR 100472) for complete details on steam room use. The manual can be downloaded at [ww.mrsteam.com/support/downloads.html](http://www.mrsteam.com/support/downloads.html)

Pairing a Bluetooth® Device to AudioWizard® 2.0

1. Initiate pairing mode from your in-shower control.

iSteam®

Press the Bluetooth button in the Music screen on the iSteam control to initiate pairing. The AudioWizard pairing mode will last for 2 minutes.

AW Control

Press and hold the UP and DOWN buttons simultaneously on the AW control for 2 seconds to initiate pairing. When in pairing mode the AW keypad will light up. The AudioWizard pairing mode will last for 2 minutes.

2. Open the Bluetooth settings on your device. Refer to your device manufacturer for specific instruction on how to reach these settings.
3. In these settings, turn Bluetooth on (if it is not already on)
4. Choose "Mr. Steam Audio" from the list of available devices.

IMPORTANT NOTE: Phone conversations may play through your AudioWizard, consult your phone's user manual to learn how to disconnect call audio.

Your mobile device should now be paired with the AudioWizard system and ready to use.

If more than one device tries to connect to the AudioWizard system, the priority goes to the first device that is available during searching.

Bluetooth® Connection

Once the Bluetooth pairing is complete and connection has been established between the devices, the AudioWizard will be ready to start playing audio.

If the device moves out of range and loses connection it should reconnect automatically as soon as it moves back into range.







A. iSteam® 2.0 Interface

Press the MUSIC button  to access the AudioWizard screen

The AudioWizard will automatically turn on when audio is sent to it.

AudioWizard automatically enters sleep mode 2 minutes after music stops.

When music is not playing the indicator light on Audiowizard2.0 will slowly flash. When music is playing the light will be steady on.

-  Previous Track *(Bluetooth® only)*  Return to Previous Screen
-  Play/Pause *(Bluetooth® only)*  Bluetooth® Pairing Button
-  Next Track *(Bluetooth® only)*
-  Increase Volume
-  Decrease Volume

iSteam 2.0 Control AudioWizard® Interface

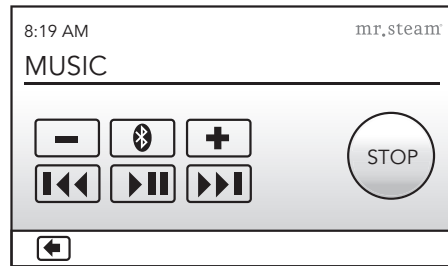

If you are using a Bluetooth® audio source, it must be connected for functions to work. Please refer to the Bluetooth pairing instructions in this manual.

Please note that the Play/Pause and Change Track functions apply to Bluetooth only, and will not work when playing audio from a hard wired music source.

B. AW Control

The AudioWizard® will automatically turn on when audio is sent to it.

AudioWizard automatically enters sleep mode 2 minutes after music stops.











When music is not playing the indicator light on Audiowizard2.0 will slowly flash. When music is playing the light will be steady on.

The AW Control will light up when music is sent to the AudioWizard and turn off when the AudioWizard enters sleep mode.

- Volume Up** Press and hold up arrow
- Volume Down** Press and hold down arrow
- Change Tracks** Momentarily press up for next track and down for previous track.

C. iSteam 1.0 Interface

AudioWizard 2.0 is compatible with iSteam 1.0. However some of the buttons are no longer required.

-  Power button is no longer needed, AudioWizard 2.0 automatically turns on when music is streamed and turns off when music is stopped.
-  Decrease Volume
-  Return to Previous Screen
-  Press to enter Pairing Mode
-  Unpair Bluetooth® is not used on AudioWizard 2.0
-  Music source buttons are no longer used. AudioWizard 2.0 automatically recognizes the music input.
-  Mute button is not used on AudioWizard 2.0
-  Previous Track *(Bluetooth® only)*
-  Play/Pause *(Bluetooth® only)*
-  Next Track *(Bluetooth® only)*
-  Increase Volume

iSteam 1.0 Control AudioWizard Interface

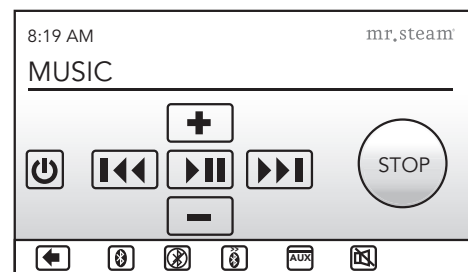

Specifications

Part Number

MS AudioWizard 2.0

Mechanical

Weight: 5 pounds
 Dimensions (W x H x D): 9¼" x 7½" x 3¼"

Electrical

Input Voltage: ~120VAC 50-60Hz
 Current Draw: 2A
 Speaker Impedance: 4-16 Ohms

Audio

Audio source supported: Bluetooth streaming and Auxiliary input
 Power output: 25 watts RMS per channel

Auxiliary Input

Stereo: Yes
 Connection type: Screw Terminal

Compatibility

Devices with Bluetooth

Applicable Standards

FCC

Warranty

To view or download the Mr. Steam® Accessory Warranty and register your product go to: blog.mrsteam.com/wr



mr.steam® | Feel Good Inc. | www.mrsteam.com

Products, information and specifications are subject to change without notice. For more information call Sales & Support at 1.800.76.STEAM (East Coast) or 1.800.72.STEAM (West Coast) for more information.

mr.steam® Sussman-Automatic Corporation® | hello@mrsteam.com | www.mrsteam.com
 43-20 34th Street, Long Island City, NY 11101 | 9410 S. La Cienega Blvd. Inglewood CA 90301
 1 800 76 STEAM FAX: 718 472 3256 | 1 800 72 STEAM FAX: 310 216 2944